

# Profit

BY PIPING LOGISTICS



**PROFLEX** FLEXIBLE SPRINKLER HOSES & APPLICATIONS

## DISCOVER OUR PROFLEX SETS

Proflex flexible sprinkler connections provide a simple and fast solution for use in automatic sprinkler systems. Our Proflex sets work with standard ceiling tiles and suspended grids, plasterboard and wooden ceilings, sandwich panels and ceilings with limited space.

***The fastest solution to connect  
your sprinkler heads!***



### UNBRAIDED



Reference	Hose size (mm)	NPT outlet
PFUH700M34BSPT12SET	700	1/2"
PFUH700M34BSPT34SET*	700	3/4"
PFUH1000M34BSPT12SET	1000	1/2"
PFUH1000M34BSPT34SET*	1000	3/4"
PFUH1200M34BSPT12SET	1200	1/2"
PFUH1200M34BSPT34SET*	1200	3/4"
PFUH1500M34BSPT12SET	1500	1/2"
PFUH1500M34BSPT34SET*	1500	3/4"
PFUH1800M34BSPT12SET	1800	1/2"
PFUH1800M34BSPT34SET*	1800	3/4"

\* ONLY AVAILABLE IN CONTAINER DIRECTLY FROM FACTORY 



**A STANDARD PROFLEX SET INCLUDES**

- **1x** flexible sprinkler hose  
→ unbraided or braided
- **1x** standard nipple 1"
- **1x** sprinkler reducer 110mm  
→ NPT outlet 1/2" or 3/4"
- **1x** center bracket
- **2x** short side clamps
- **1x** bar 700mm
- **2x** EPDM gaskets

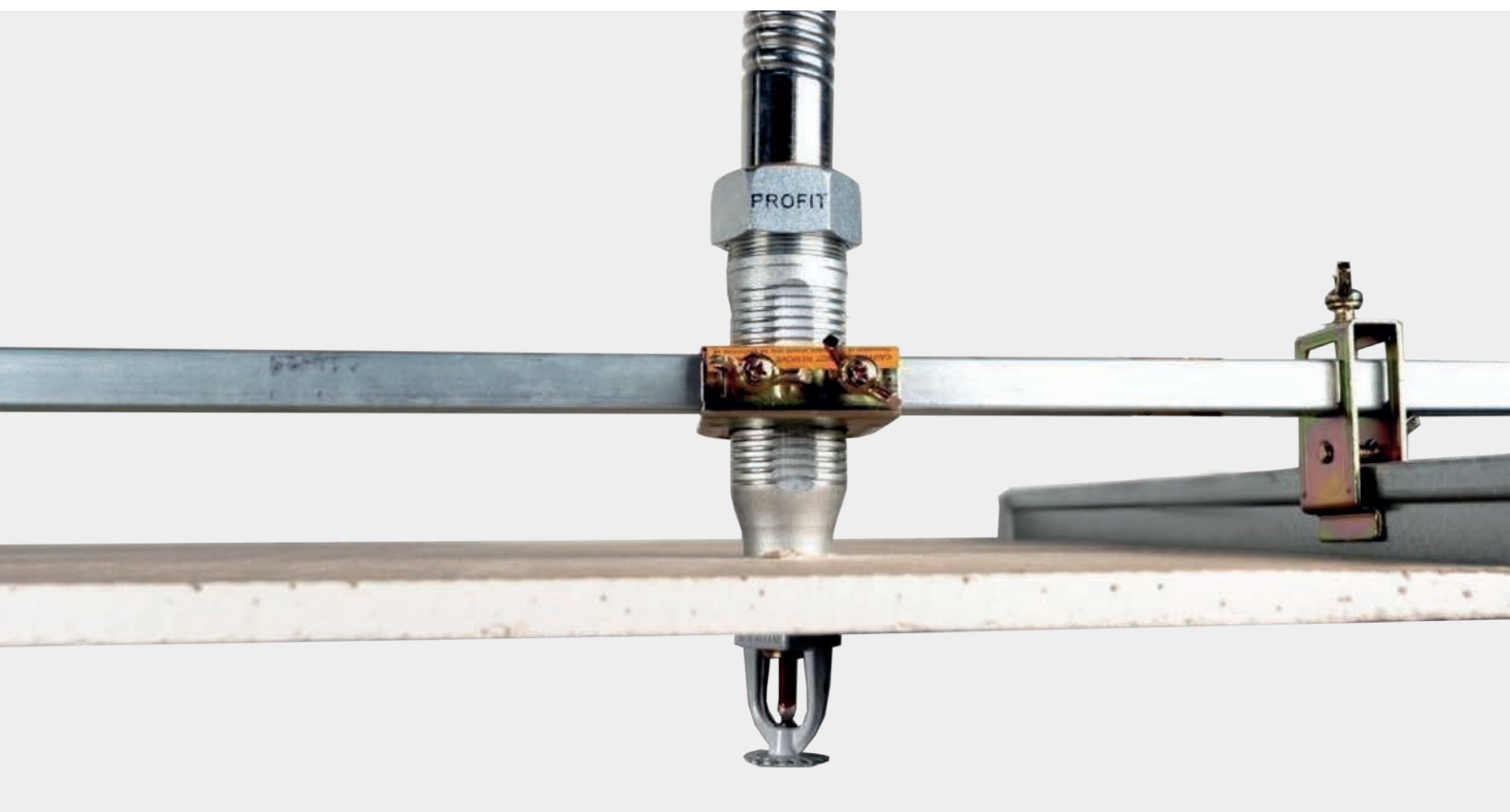

**BRAIDED**



Reference	Hose size (mm)	NPT outlet
PFBH700M34BSPT12SET	700	1/2"
PFBH700M34BSPT34SET*	700	3/4"
PFBH1000M34BSPT12SET	1000	1/2"
PFBH1000M34BSPT34SET*	1000	3/4"
PFBH1200M34BSPT12SET	1200	1/2"
PFBH1200M34BSPT34SET*	1200	3/4"
PFBH1500M34BSPT12SET	1500	1/2"
PFBH1500M34BSPT34SET*	1500	3/4"
PFBH1800M34BSPT12SET	1800	1/2"
PFBH1800M34BSPT34SET*	1800	3/4"

\* ONLY AVAILABLE IN CONTAINER DIRECTLY FROM FACTORY 



## STANDARD REDUCER

With this option it's possible to change the length and size of the Proflex outlet.

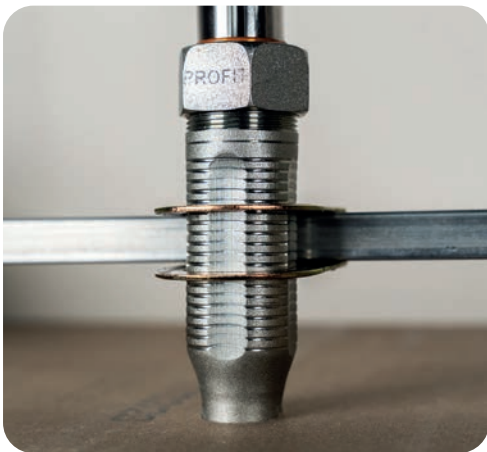

### 110MM

Available with NPT 1/2" and 3/4"



#### References:

- PF-STR-NPT-1/2M34P NPT 1/2
- PF-STR-NPT-3/4M34P NPT 3/4

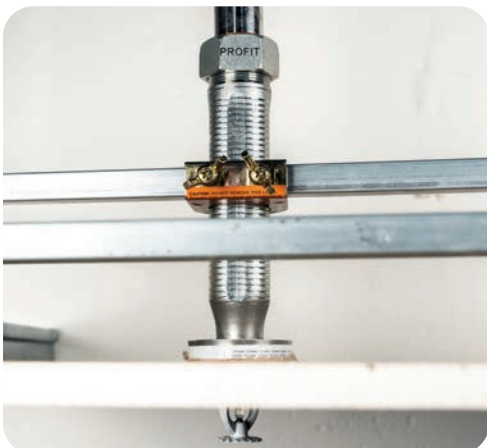

### OPTIONAL: 155MM

Available with NPT 1/2" and 3/4"

#### References:

- PF-STR-NPT-1/2M34P155 NPT 1/2
- PF-STR-NPT-3/4M34P155 NPT 3/4

## STANDARD CLAMP

Side bracket to clamp the Proflex square bar onto standard suspended ceilings.

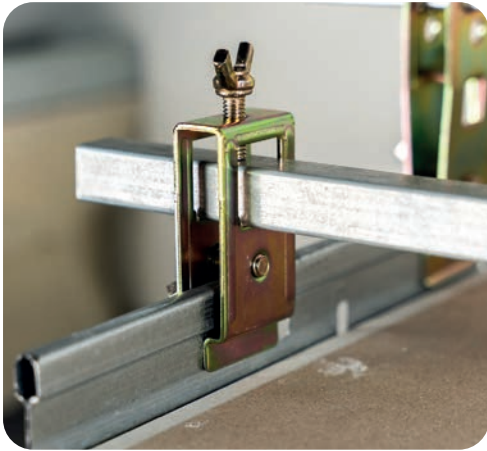

### SHORT SIDE CLAMP • 62MM

Standard side bracket, used with **pendent** sprinkler-heads.

**Reference:**  
PF-STC-SP

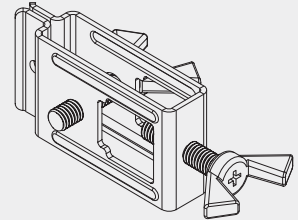

### OPTIONAL: LONG SIDE CLAMP • 105MM

Long side bracket, used with **concealed** sprinkler heads.

**Reference:**  
PF-STC-LP



## STANDARD CENTER BRACKET



### CENTER BRACKET

Center bracket to clamp reducers, used in standard **suspended** ceilings.

**Reference:**  
PF-STBP

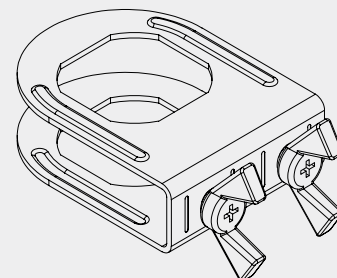

## ELBOW REDUCER

Elbow reducers are being used in low profile installations (limited space between ceiling and sprinkler tubes). Available with NPT 1/2" and 3/4".

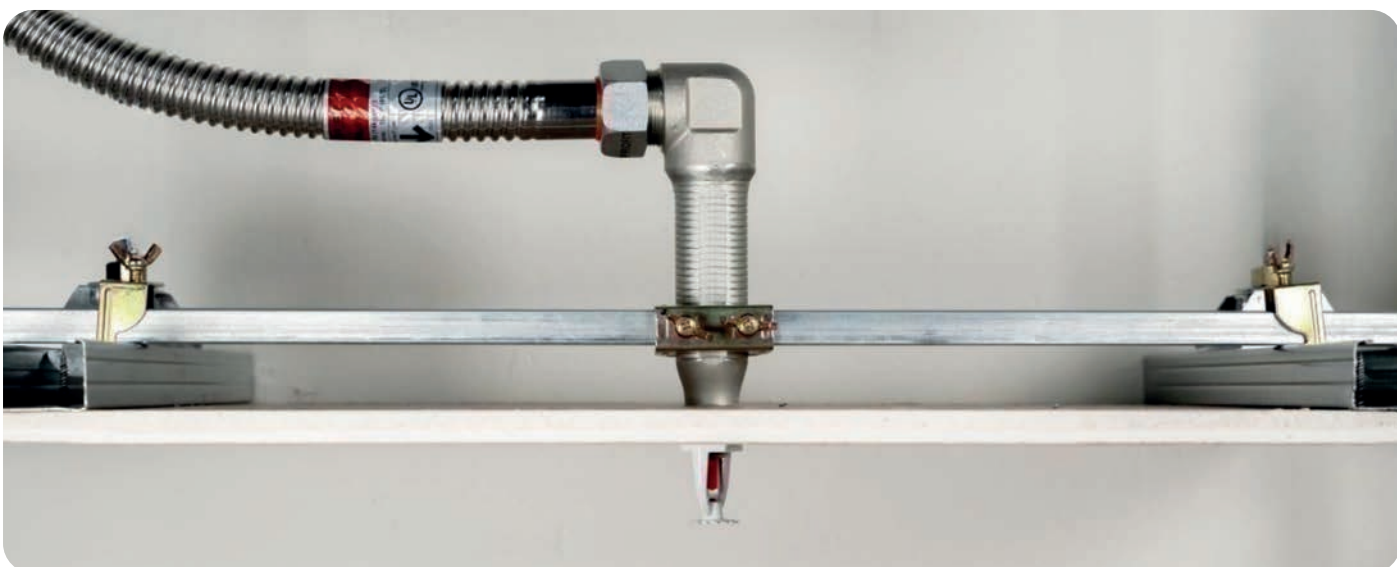

### 110MM

**References:**

PF-ELR-110-1/2  
PF-ELR-110-3/4

NPT 1/2  
NPT 3/4

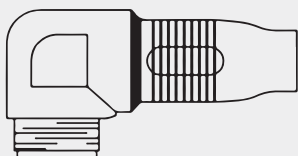

### 155MM

**References:**

PF-ELR-155-1/2  
PF-ELR-155-3/4

NPT 1/2  
NPT 3/4

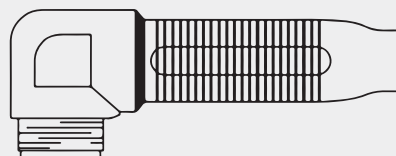

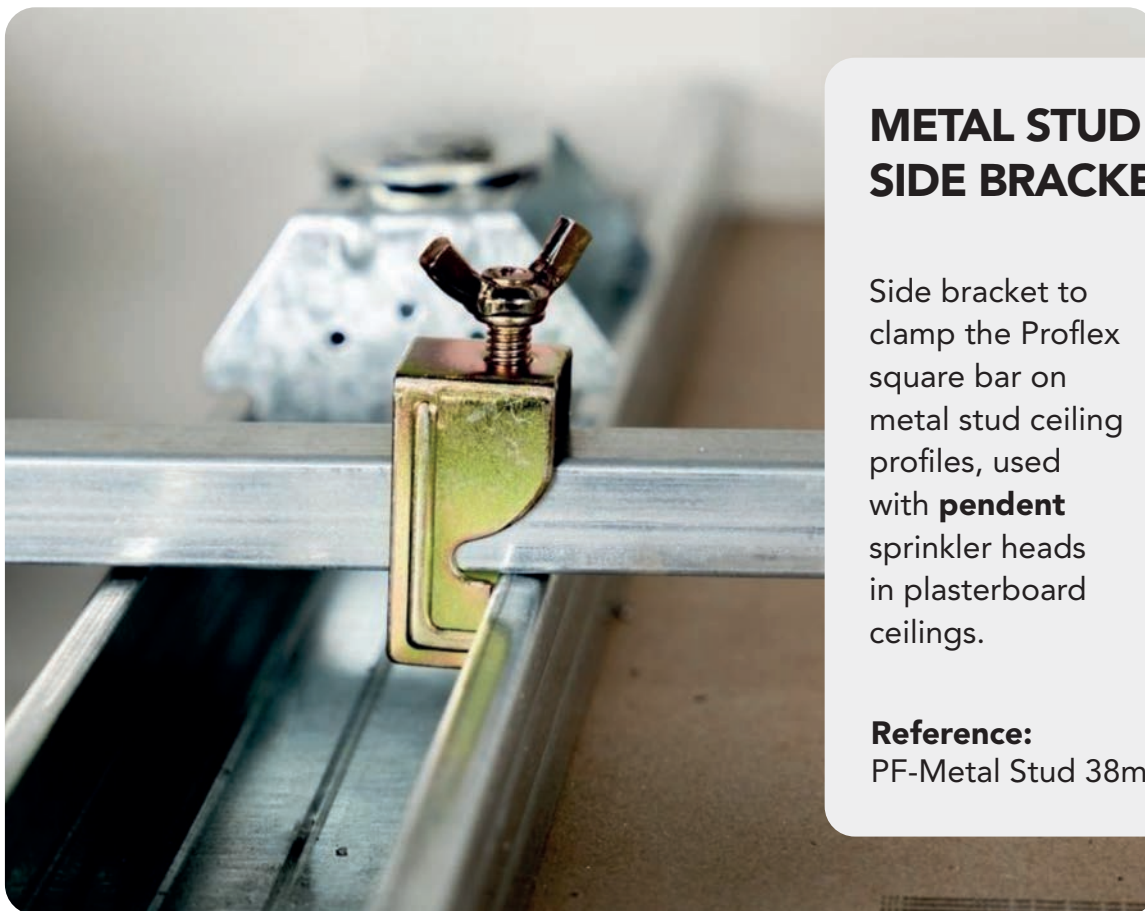

## PLASTERBOARD CEILINGS

**METAL STUD  
SIDE BRACKET • 38MM**

Side bracket to clamp the Proflex square bar on metal stud ceiling profiles, used with **pendent** sprinkler heads in plasterboard ceilings.

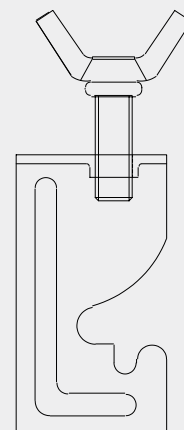

**Reference:**  
PF-Metal Stud 38mm

**METAL STUD  
SIDE BRACKET • 53MM**

Side bracket to clamp the Proflex square bar on metal stud ceiling profiles, used with **concealed** sprinkler heads in plasterboard ceilings.

**Reference:**  
PF-Metal Stud 53mm

## SANDWICH PANELS



### PANEL FIT REDUCER SET

Special reducer set designed for an easy installation of sprinkler hoses in sandwich panels.

One set contains a 300mm twin-threaded reducer with 1/2" outlet + all parts to install a Proflex hose (including gaskets and screws).

#### References:

PF-PFR	NPT 1/2
PF-PFR-3/4	NPT 3/4

OPTION 1



PENDENT SPRINKLER

» single joint plate

OPTION 2



CONCEALED SPRINKLER

» single joint plate

OPTION 3

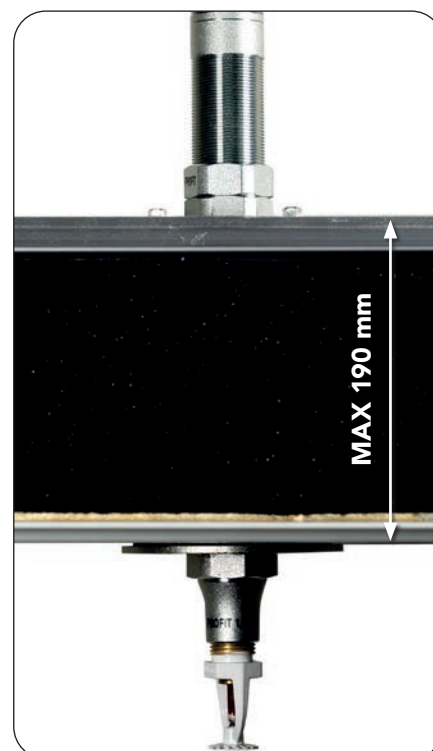

» two joint plates



**A PANEL FIT REDUCER SET INCLUDES**

**01 Reducer with external thread with NPT 1/2" or 3/4"**

1 piece

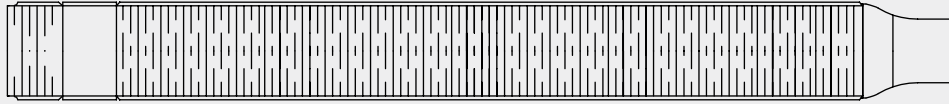

**02 Joint plate**

2 pieces

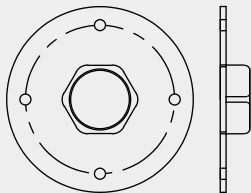

**03 Expanded rubber gasket**

2 pieces

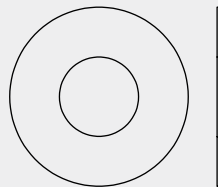

**04 Locking nut**

1 piece

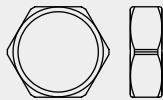

**05 Self-drilling installation screws**

8 pieces

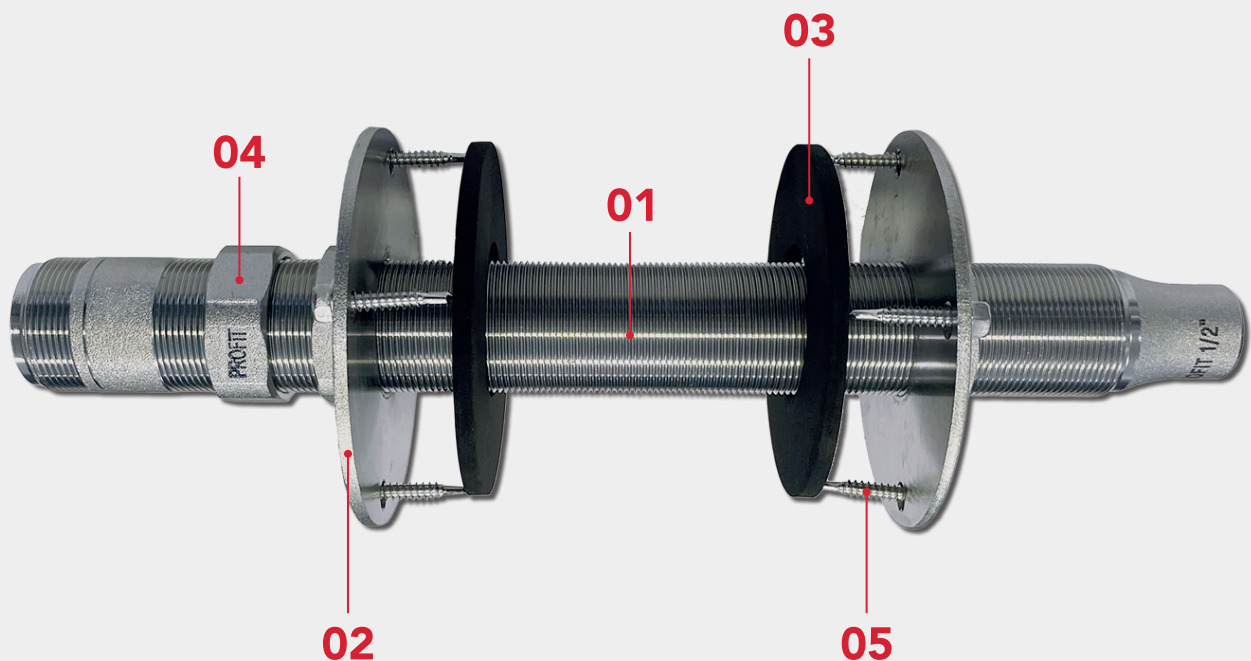

## LIMITED CEILING SPACE

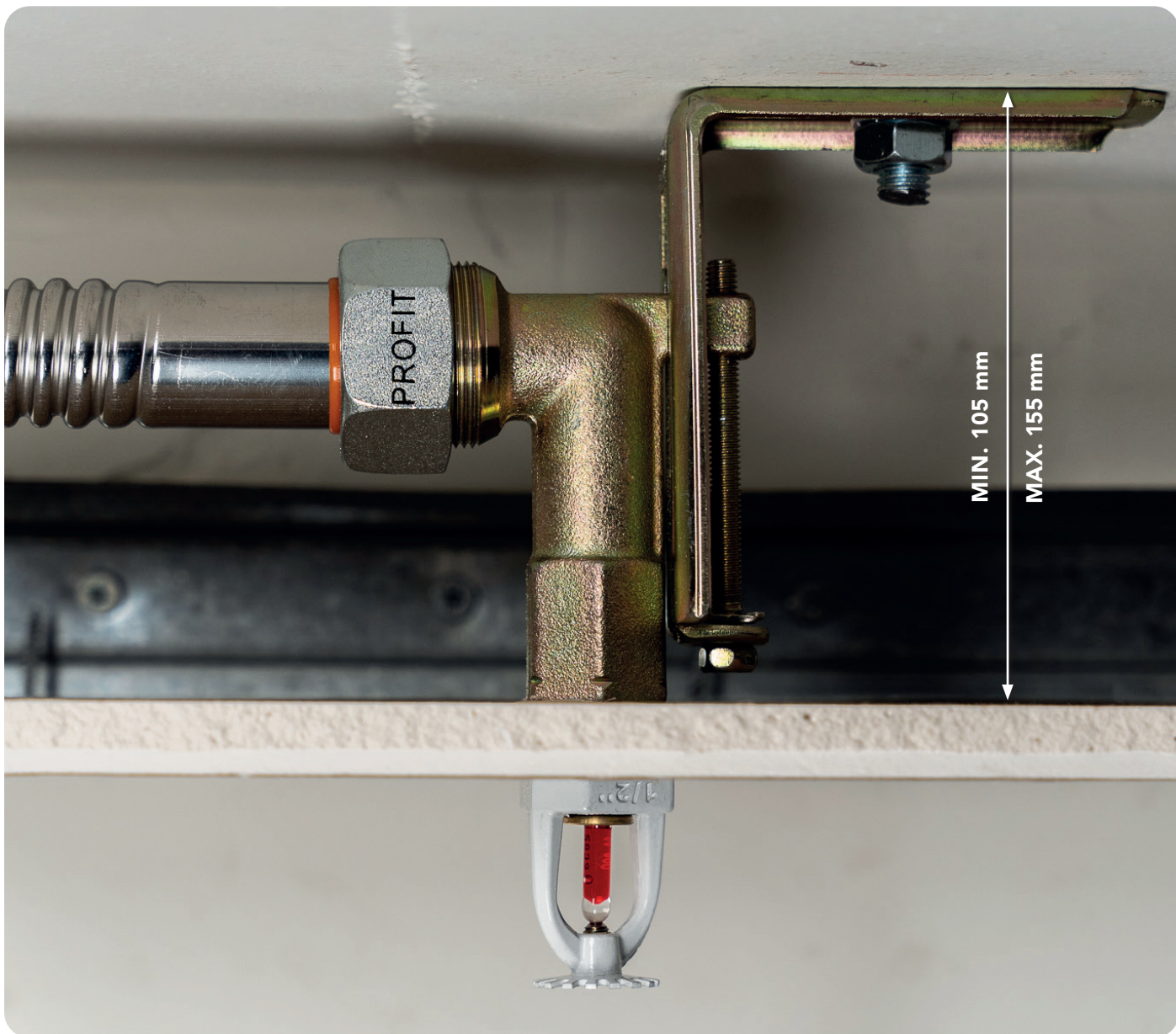

### ELBOW BRACKET REDUCER

Special reducer to be used in **suspended** ceilings with very small available space or in applications where the standard suspended ceiling grid is missing.

The corner profile can be fixed for example in concrete floor slabs. It comes with an elbow reducer 1/2" with adjustable vertical position (105-155 mm).

**Reference:**  
PF-EBR

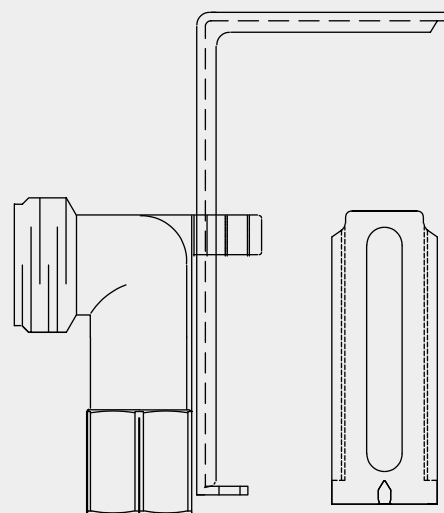



## WOODBREAM CEILINGS

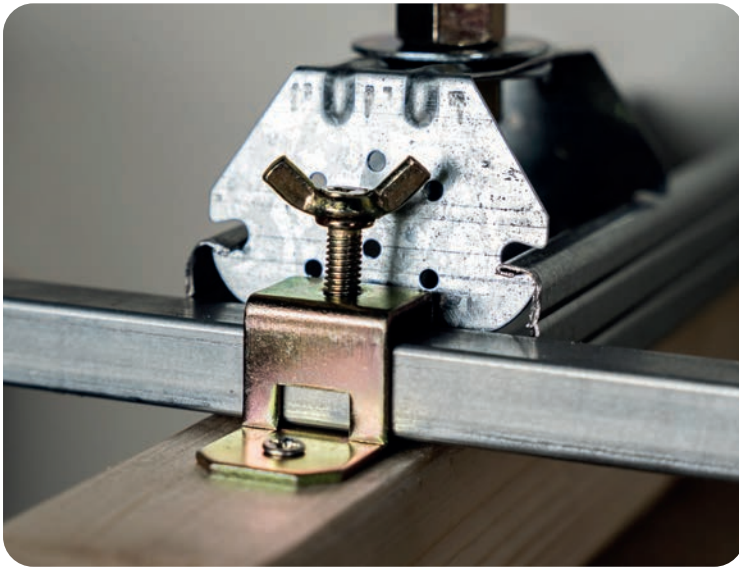

### WOODBREAM SIDE BRACKET

Side bracket to clamp the Proflex square bar, for application on **wooden surfaces**.

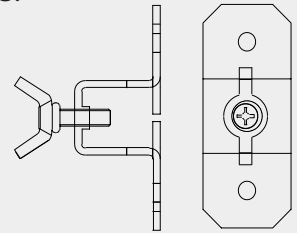

**Reference:**  
PF-SBWB



DATASHEET

### MORE TECHNICAL DETAILS

Scan the QR code to open the technical datasheet of our Proflex products, where you can find all technical details including material specifications, dimensions, certifications and more.





# Profit ON SITE

NOW AVAILABLE

PROFIT ON SITE

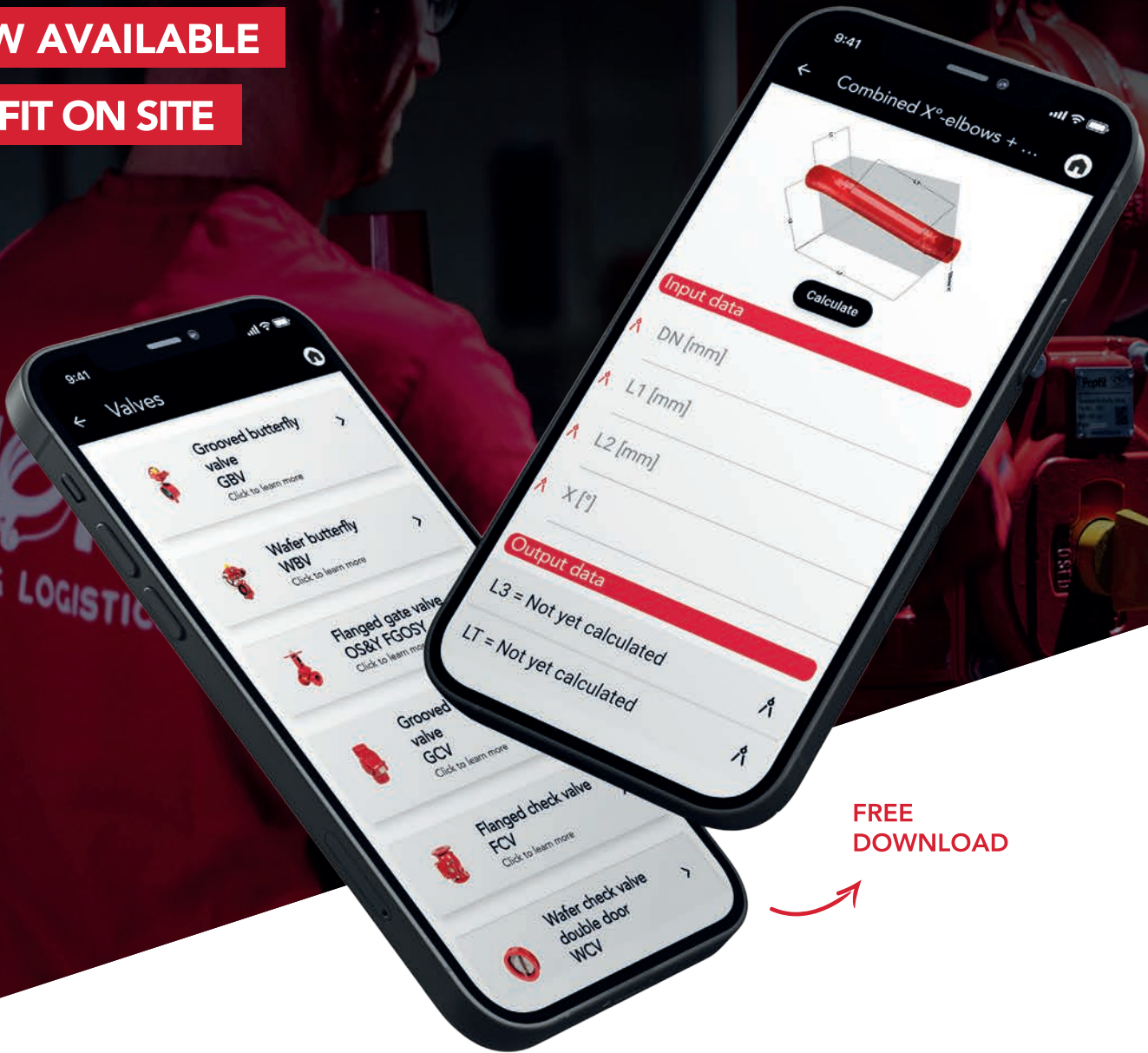

FREE  
DOWNLOAD

DIRECT ACCESS TO TECHNICAL PRODUCT INFORMATION,  
CALCULATIONS AND COMBINATIONS.

SAVE TIME WITH PROFIT ON SITE

With the **Profit On Site** app on your smartphone or tablet, you have direct access to all technical information about Profit brand products, whether you are **on site or on the road**. This **user-friendly** app is the perfect tool for an **extensive product overview** with drawings, calculations and combinations. Simple & **fast access** to dimensional product information, latest technical datasheets, installation instructions and video tutorials. **Save time** with the **Profit On Site** app by quickly finding what you need in one place!

## MAIN FEATURES

- Length calculations of combined fitting-fitting and fitting-pipespool combinations (2D & 3D).
- Offline access to all dimensional product data, including technical drawings (zoom-in possible).
- Online access to:
  - Installation instructions.
  - Technical datasheets.
  - Videos & tutorials.
- Save time: quickly find all info in one place.
- Fast, convenient and user-friendly.

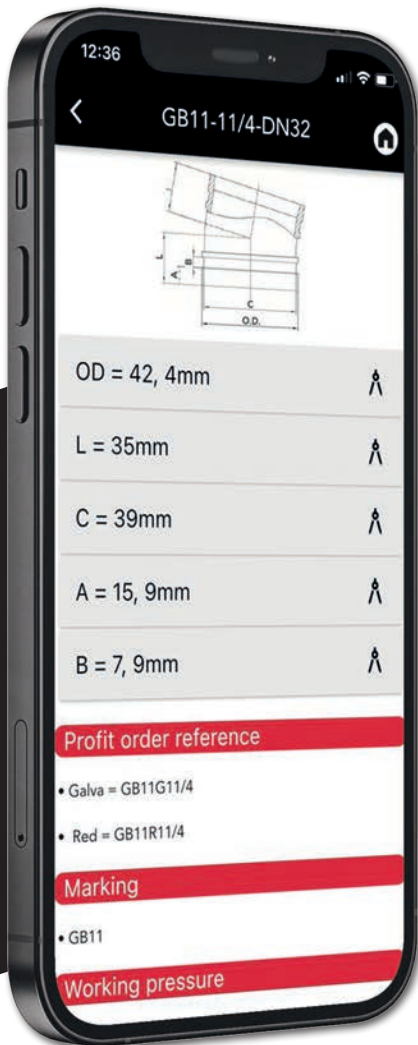

**DOWNLOAD  
OUR APP**



SCAN ME





## DISCOVER OUR COMPLETE PRODUCT RANGE

Scan the QR code to open our product catalogue, where you can find all our products and their main features, dimensions, certifications and more. Together with high quality pictures and some references.





COUPLINGS & FITTINGS



PREFABRICATED SPRINKLER PIPES



VALVES



SWITCHES



FLEXIBLE HOSES



ACCESSORIES





**Piping Logistics bv**

Industrielaan 27  
9320 Erembodegem  
Belgium

T: +32 (0)53 64 51 00

info@pipinglogistics.eu  
www.pipinglogistics.eu

Edition 2024-09-05

Follow us online:

